

描述

MIX2051是一款高效率、无输出滤波器的单声道6W带防破音功能F类音频功率放大器。

MIX2051的差分输入架构和极高的PSRR有效地提高了MIX2051对RF噪声的抑制能力。防破音功能解决了不同音源输出幅度不一致的问题，同时带来不失真的完美音乐享受。无需滤波器的PWM调制结构及增益内置方式减少了外部元件、PCB面积和系统成本,并简化了设计。高达90%的效率，快速启动时间和纤小的封装尺寸使得MIX2051成为蓝牙音箱和其他便携式音频产品的最佳选择。

MIX2051具有关断功能，极大的延长系统的待机时间。过热保护功能增强系统的可靠性。POP声抑制功能改善了系统的听觉感受，同时简化系统调试。

MIX2051提供ESOP8封装

特性

- D类输出功率：
 - 6W (5.5V, $R_L = 2 \Omega$, THD+N=10%)
 - 3.9W (5.5V, $R_L = 4 \Omega$, THD+N=10%)
- AB类输出功率：
 - 5.3W (5.5V, $R_L = 2 \Omega$, THD+N=10%)
 - 3.5W (5.5V, $R_L = 4 \Omega$, THD+N=10%)
- 工作电压：2.8V to 5.5V
- 低失真和低噪声
- 两种防破音模式可选
- 防破音功能可关闭
- 开机POP声抑制功能
- 关机电流小于1uA
- 过热保护功能

应用

- 蓝牙音箱 / 插卡音响
- 背包音箱 / 对箱

典型应用电路图

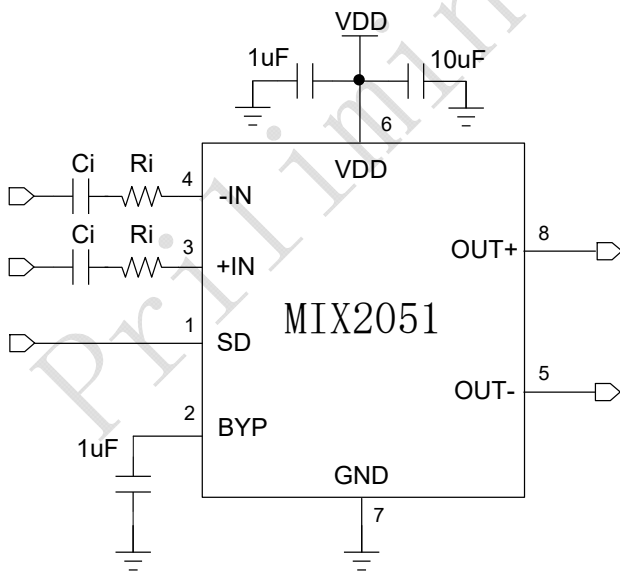

引脚排列

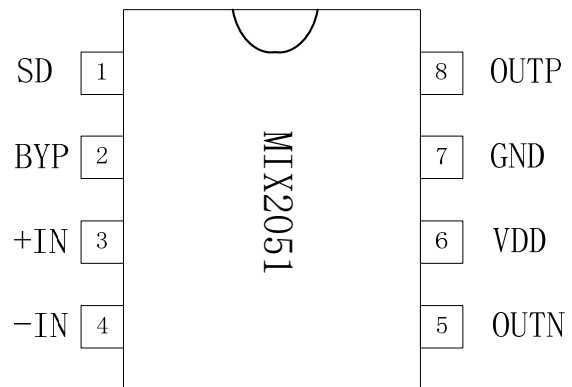

功能框图

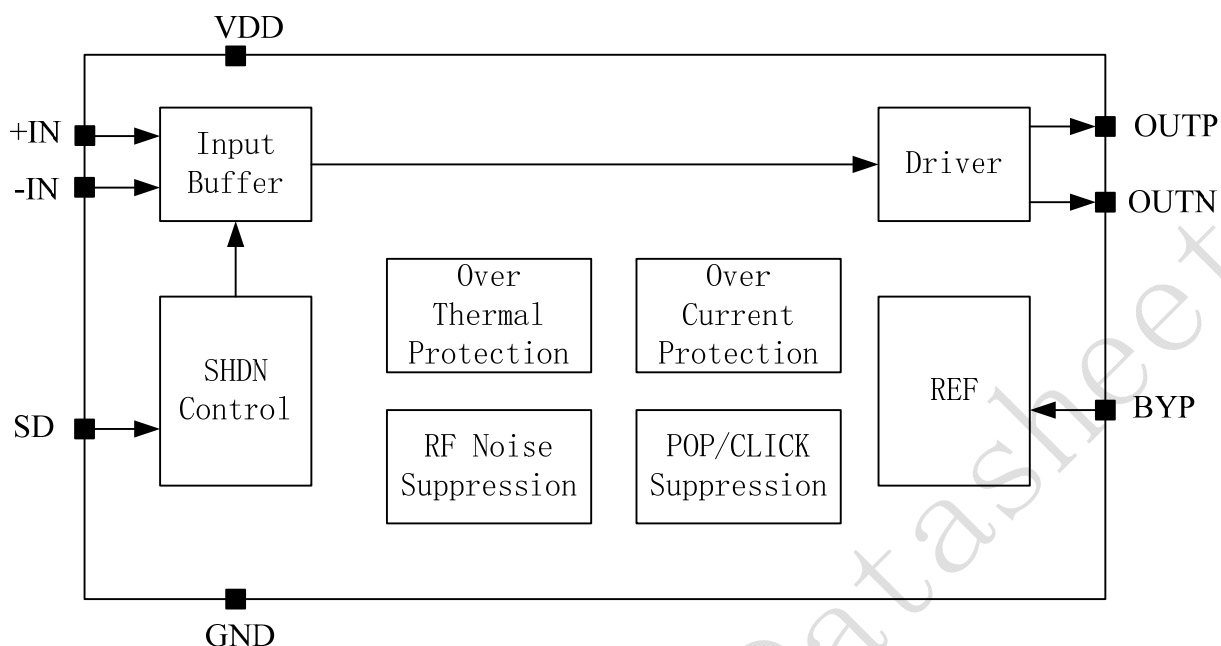

管脚描述

管脚	符号	I/O	描述
1	SD	I	系统关断控制（高电平工作，低电平关机） 同时具有一线脉冲防破音功能控制
2	BYP	I	旁路
3	+IN	I	音频正输入端
4	-IN	I	音频负输入端
5	OUTN	O	音频负输出端
6	VDD		电源
7	GND		地
8	OUTP	O	音频正输出端

MIX2051

6W 单通道防破音 F 类功放



订货信息

料号	封装	表面印字	包装
MIX2051-Reel	ESOP8	MIX2051 XXXXXXX	4000 颗/卷
MIX2051-Tube	ESOP8	MIX2051 XXXXXXX	100 颗/管

绝对最大额定值

V _{DD}	供电电压	-0.3V to 6.0V
V _I	输入电压	-0.3V to V _{DD} +0.3V
T _A	工作温度	-40°C to 85°C
T _J	结温	-40°C to 125°C
T _{STG}	储存温度	-65°C to 150°C
T _{SLD}	焊接温度	300°C, 5sec

推荐额定值

			MIN	MAX	UNIT
V _{DD}	供电电压	VDD	2.8	5.5	V
V _{IH}	SD, ENB 高电平	VDD=5.0V	1.6		V
V _{IL}	SD, ENB 低电平	VDD=5.0V		0.8	V

热阻参数

Parameter	Symbol	Package	MAX	UNIT
热阻 (Junction to Ambient)	θ_{JA}	ESOP8	90	°C/W
热阻 (Junction to Case)	θ_{JC}	ESOP8	11	°C/W

D Mode Electrical Characteristics

(VDD =5V, Gain=20dB, RL =4Ω, T =25°C, unless otherwise noted.)

Symbol	Parameter	Test Conditions	MIN	TYP	MAX	UNIT
V _{IN}	Supply Voltage		2.8	-	5.5	V
P _O	Output Power	THD+N=10%,f=1KHZ,R _L =2 Ω	V _{DD} =5.0V	5.1		W
			V _{DD} =3.6V	2.5		W
		THD+N=10%,f=1KHZ,R _L =4 Ω	V _{DD} =5.0V	3.1		W
			V _{DD} =3.6V	1.6		W
		THD+N=1%,f=1KHZ,R _L =2 Ω	V _{DD} =5.0V	4.1		W
			V _{DD} =3.6V	1.7		W
		THD+N=1%,f=1KHZ,R _L =4 Ω	V _{DD} =5.0V	2.6		W
			V _{DD} =3.6V	1.3		W
THD+N	Total Harmonic Distortion Plus Noise	V _{DD} =5.0V, P _O =4W, R _L =2 Ω	f=1KHZ	0.2		%
		V _{DD} =3.6V, P _O =2W, R _L =2 Ω		1		%
		V _{DD} =5.0V, P _O =2W, R _L =4 Ω	f=1KHZ	0.1		%
		V _{DD} =3.6V, P _O =1W, R _L =4 Ω		0.1		%
G _v	Gain	R _i = 33K		23		dB
PSRR	Power Supply Ripple Rejection	V _{DD} =4.2V±200mVp-p	f=1KHZ	60		dB
SNR	Signal-to-Noise Ratio	V _{DD} =5.0V, V _{o rms} =1V, G _v =20dB	f=1KHZ	85		dB
V _n	Output Noise	V _{DD} =5.0V, Input floating with C _{IN} =0.1μF	A-weighting	100		μV
			No A-weighting	150		μV
Dyn	Dynamic Range	V _{DD} =5.0V, THD=1%	f=1KHZ	90		dB
η	Efficiency	V _{DD} =5.0V, R _L =2 Ω, P _O =5W	f=1KHZ	83		%
		V _{DD} =5.0V, R _L =4 Ω, P _O =2.8W		90		%
I _Q	Quiescent Current	V _{DD} =5.0V	No Load	10		mA
		V _{DD} =3.6V		5		mA
I _{SD}	Shutdown Current	V _{DD} =3V to 5V	V _{SD} =0V		1	μA
V _{OS}	Offset Voltage	V _{IN} =0V, V _{DD} =5V		10		mV
F _{osc}	Oscillator Frequency			360		khz
T _{st}	Setup Time	Bypass capacitor =1uF		300		mS
OTP	—	No Load, Junction	V _{DD} =5.0V	180		°C
OTH	—	Temperature		40		°C

D Mode Typical Operating Characteristics

(VDD =5V, Gain=20dB, RL =4Ω, T =25°C, unless otherwise noted.)

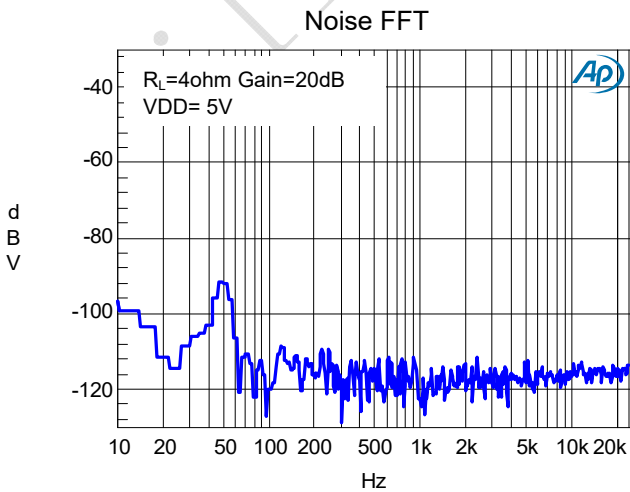
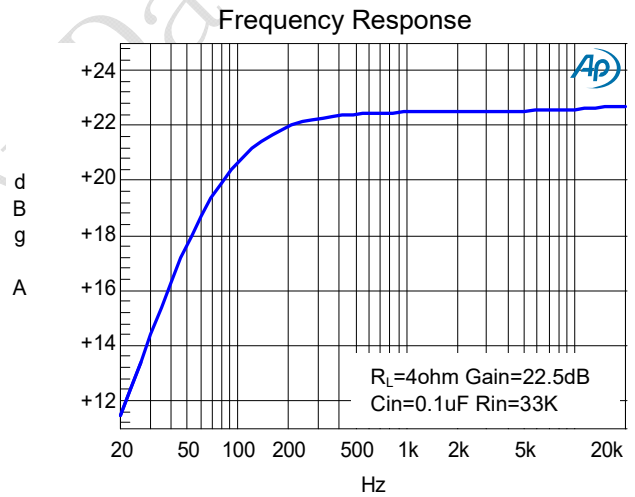
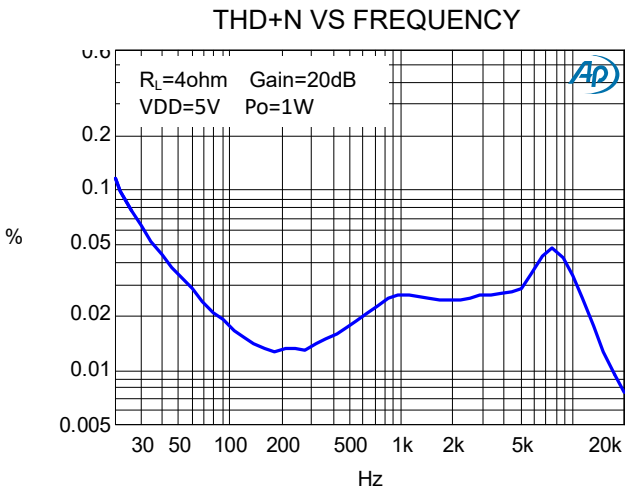
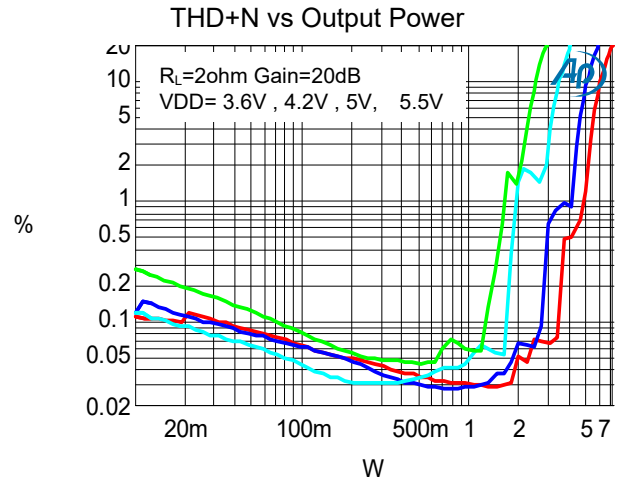
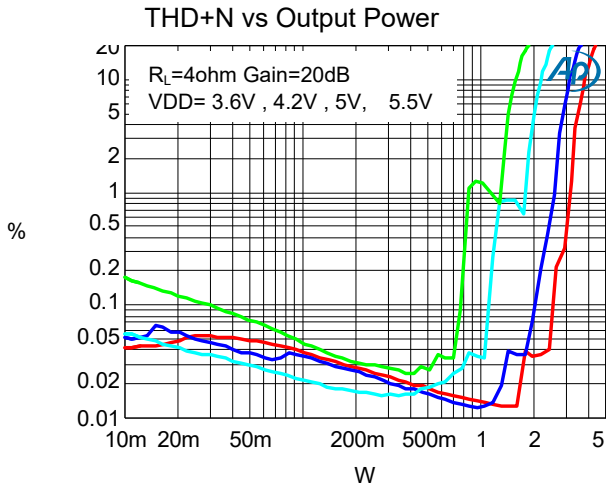

F Mode Electrical Characteristics

(VDD = 5V, Gain=20dB, RL = 4Ω, T = 25°C, unless otherwise noted.)

Symbol	Parameter	Test Conditions	MIN	TYP	MAX	UNIT
V _{IN}	Supply Voltage		2.8	-	5.5	V
P _O	Output Power	THD+N=10%, f=1KHZ, RL=2 Ω	V _{DD} =5.0V	4.5		W
			V _{DD} =3.6V	1.8		
		THD+N=10%, f=1KHZ, RL=4 Ω	V _{DD} =5.0V	2.9		W
			V _{DD} =3.6V	1.2		
		THD+N=1%, f=1KHZ, RL=2 Ω	V _{DD} =5.0V	3.4		W
			V _{DD} =3.6V	1.4		
		THD+N=1%, f=1KHZ, RL=4 Ω	V _{DD} =5.0V	2.3		W
			V _{DD} =3.6V	0.9		
THD+N	Total Harmonic Distortion Plus Noise	V _{DD} =5.0V, P _O =3W, RL=2 Ω	f=1KHz	1		%
				V _{DD} =3.6V, P _O =1.5W, RL=2 Ω	2	
		V _{DD} =5.0V, P _O =1.5W, RL=4 Ω	f=1KHz	0.1		%
				V _{DD} =3.6V, P _O =0.75W, RL=4 Ω	0.2	
G _v	Gain	R _i = 33K		23		dB
PSRR	Power Supply Ripple Rejection	V _{DD} =4.2V ± 200mVp-p	f=1KHz	60		dB
SNR	Signal-to-Noise Ratio	V _{DD} =5.0V, V _{o rms} =1V, G _v =20dB	f=1KHz	85		dB
V _n	Output Noise	V _{DD} =5.0V, Input floating with C _{IN} =0.1μF	A-weighting	100		μV
			No	150		
			A-weighting			
Dyn	Dynamic Range	V _{DD} =5.0V, THD=1%	f=1KHz	90		dB
I _Q	Quiescent Current	V _{DD} =5.0V	No Load	20		mA
		V _{DD} =3.6V		12		
I _{SD}	Shutdown Current	V _{DD} =3V to 5V	V _{SD} =0V		1	μA
V _{OS}	Offset Voltage	V _{IN} =0V, V _{DD} =5V		10		mV
T _{st}	Setup Time	Bypass capacitor = 1μF		300		mS
OTP	—	No Load, Junction Temperature	V _{DD} =5.0V	180		°C
OTH	—			40		

AB Mode Typical Operating Characteristics

(VDD =5V, Gain=20dB, RL =4Ω, T =25°C, unless otherwise noted.)

THD+N vs Output Power

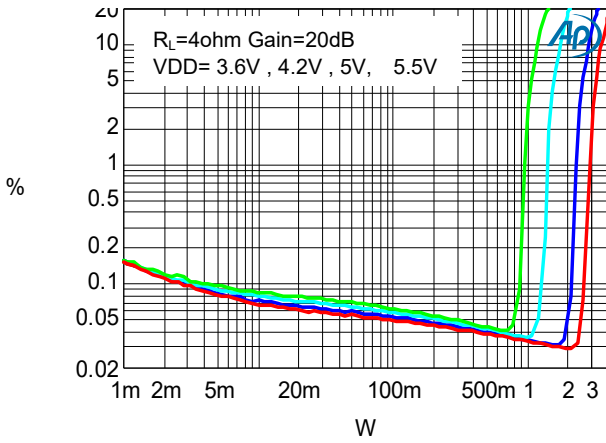

THD+N vs Output Power

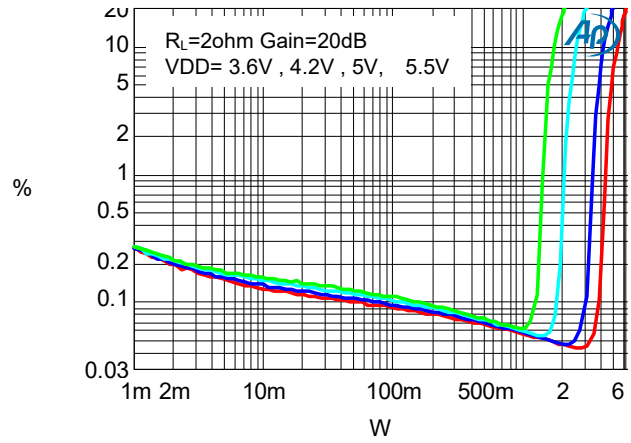

THD+N VS FREQUENCY

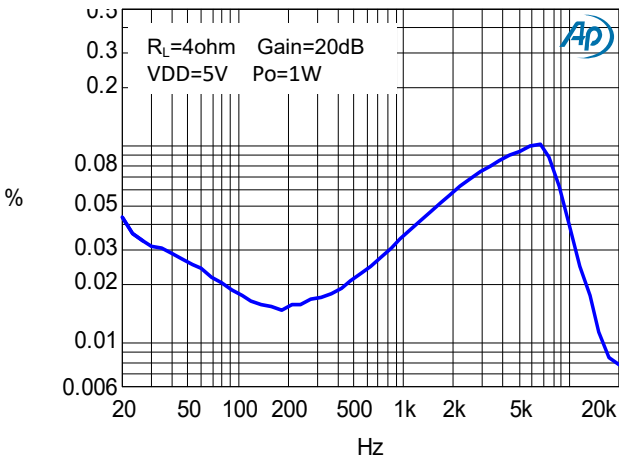

Frequency Response

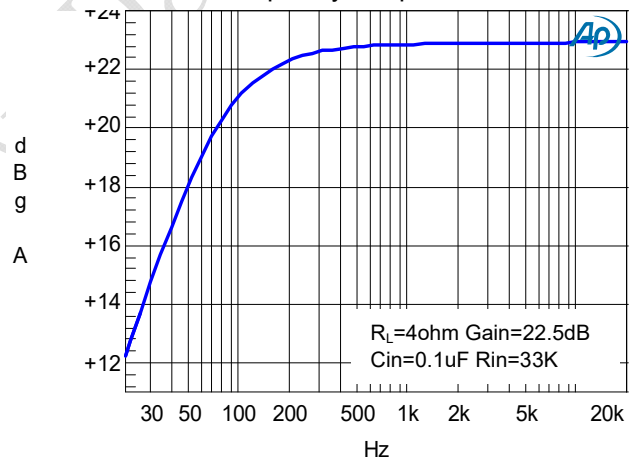

Noise FFT

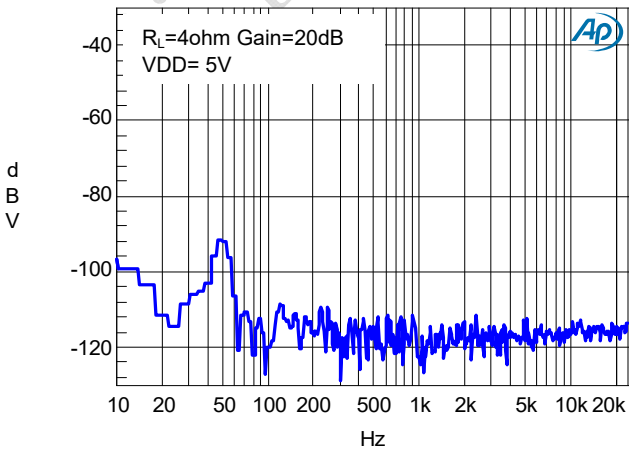

应用信息

输入电阻(Ri)

MIX2051的增益由音量调节控制的输入电阻(RI)和反馈电阻(RF)控制。有如下的增益计算公式：

$$A_v = 2 \times \frac{R_f}{R_e} \left(\frac{V}{V} \right)$$

其中， R_e 为芯片外部的可调节输入电阻；反馈电阻 R_f 为225K（反馈电阻为内部固定，不可外部调节）。例如，外部输入电阻为33K，则放大倍数为：

$$A_v = 2 \times 225 / (33) = 13.6 \text{ 倍} = 23 \text{ dB}$$

输入电容 (Ci)

输入电容与输入电阻构成一个高通滤波器，其截止频率可由下式得出：

$$f_c = \frac{1}{(2\pi R_i C_i)}$$

C_i 的值不仅会影响到电路的低频响应，而且也会影响到电路启动和关断时所产生的POP声，输入电容越大，则到达其稳定工作点所需的电荷越多，在同等条件下，小的输入电容所产生的POP声比较小。

SD管脚控制

SD管脚是功放的使能管脚。SD管脚为高电平时，功放正常工作，SD管脚为低电平时，功放关断。芯片有三个工作状态，分别是D类防破音模式1，D类防破音模式2，D类防破音关闭。如果SD管脚直接拉高，不输入一线脉冲信号，MIX2051默认进入到D类防破音模式1。如果SD管脚输入一线脉冲信号，则MIX2051进入到相对应的工作模式。

D类防破音模式1的输出音量比D类防破音模式2要大一些，但是失真同时也大一些。追求较低失真同时要求防破音功能，可以选择D类防破音模式2。如果追求较大的声音，则选择D类防破音模式1。

如果不需要防破音功能，则选择D类防破音关闭的工作模式。

一线脉冲控制方式如下：

1.切换到D类防破音模式1的波形

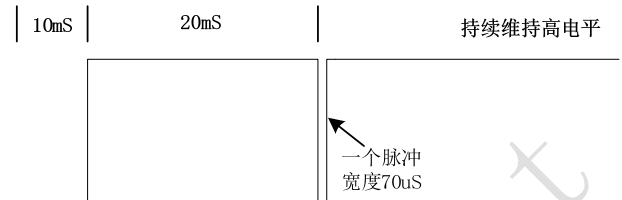

2.切换到D类防破音模式2的波形

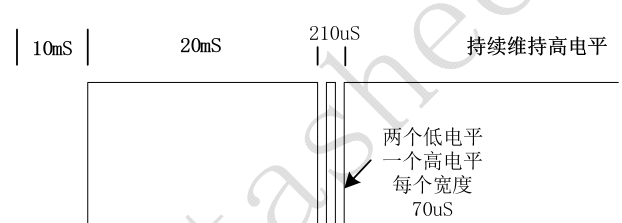

3.切换到D类防破音关闭的波形

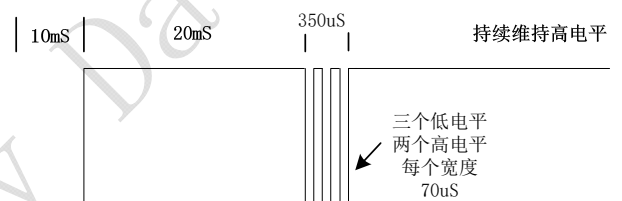

4.切换到AB类防破音关闭的波形

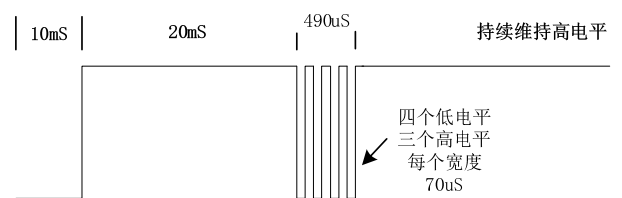

偏置电容C_{BYP}

偏置电容是很关键的电容，它与几个重要性能相关，当电路启动时，偏置电容决定了放大器的开启速度，偏置电容同时会影响到电路的噪声，电源抑制比以及开关机的POP声。

为避免启动时的POP声，偏置电压的上升速度应该比输入偏置电压的上升速度慢。

过温保护

MIX2051带有过温保护电路以防止内部温度超过 180℃ 时器件损坏。在不同器件之间，这个值有25℃的差异。当内部电路超过设置的保护温度时，器件进入关断状态，输出被截止。当温度下降 30℃后，器件重新正常工作。

封装图 (ESOP8)

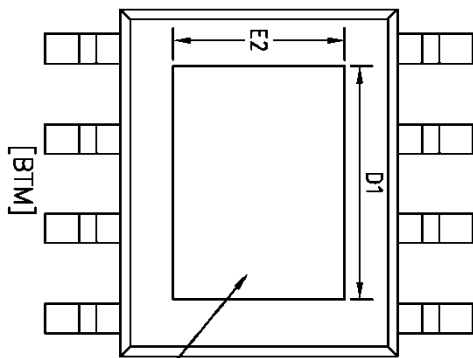
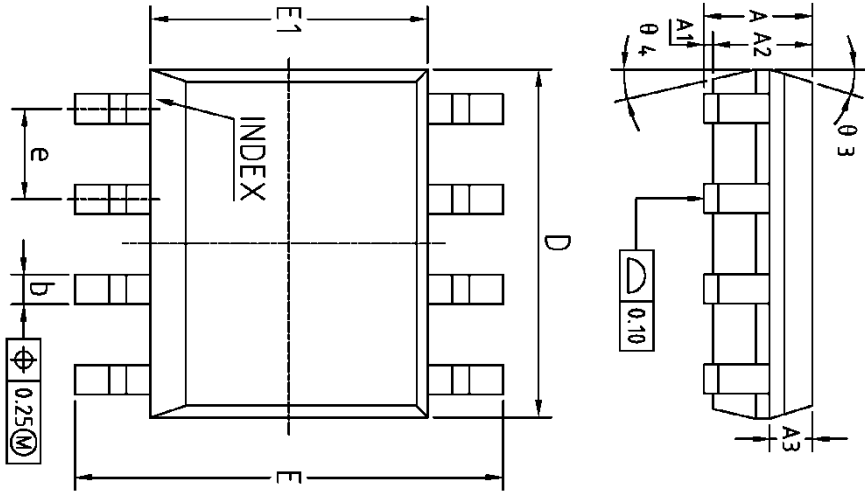

NOTES:
ALL DIMENSIONS REFER TO JEDEC STANDARD MS-012 AA
DO NOT INCLUDE MOLD FLASH OR PROTRUSIONS.

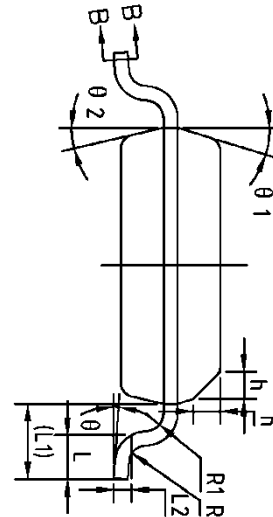

COMMON DIMENSIONS
(UNITS OF MEASURE=MILLIMETER)

SYMBOL	MIN	NOM	MAX
A	1.35	1.35	1.75
A1	0	0.10	0.15
A2	1.25	1.40	1.65
A3	0.50	0.60	0.70
b	0.38	-	0.51
b1	0.37	0.42	0.47
c	0.17	-	0.25
c1	0.17	0.20	0.23
D	4.80	4.90	5.00
D1	3.10	3.30	3.50
E	5.80	6.00	6.20
E1	3.80	3.90	4.00
E2	2.20	2.40	2.60
e	-	1.27BSC	-
L	0.45	0.60	0.80
L1	-	1.04REF	-
L2	-	0.25BSC	-
R	0.07	-	-
R1	0.07	-	-
h	0.30	0.40	0.50
theta	0°	-	8°
theta 1	15°	17°	19°
theta 2	15°	17°	19°
theta 4	15°	15°	15°

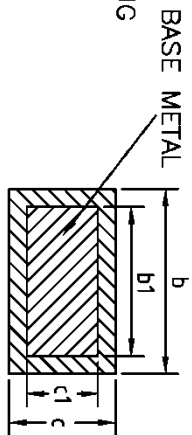

声明：上海矽诺微电子有限公司不对本公司产品以外的任何电路使用负责，也不提供其专利许可。上海矽诺微电子有限公司保留在任何时间、没有任何通报的前提下修改产品资料和规格的权利。